

# OSIEDLE BAJKOWE ETAP III

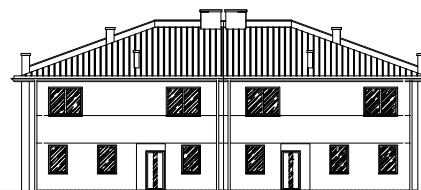

ELEWACJA FRONTOWA

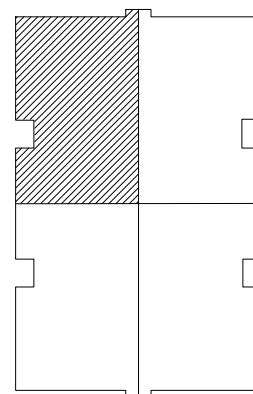
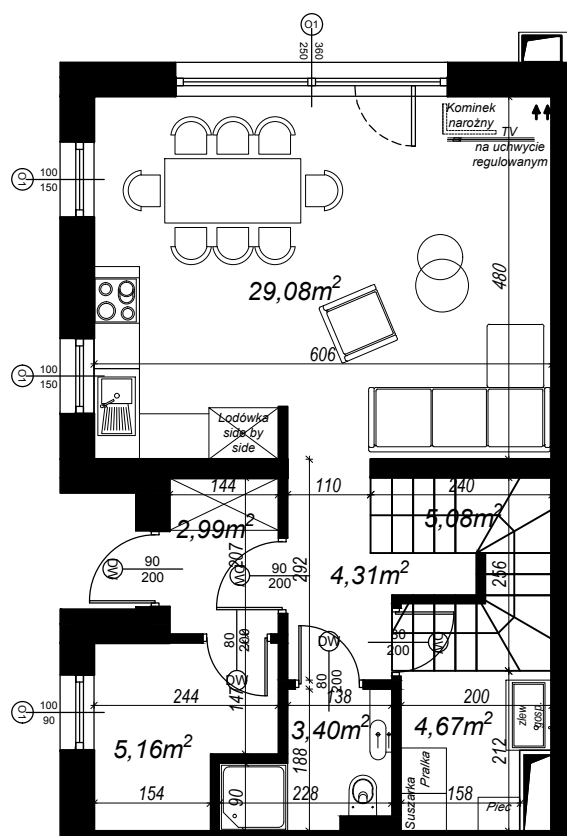
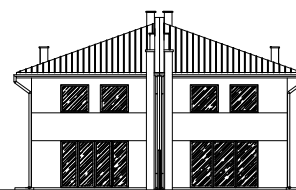

ELEWACJA BOCZNA

NR	NAZWA	POW
0.1	Wiatrołap	2,99 m <sup>2</sup>
0.2	Korytarz	4,31 m <sup>2</sup>
0.3	Salon z aneksem	29,08 m <sup>2</sup>
0.4	Schody	5,08 m <sup>2</sup>
0.5	Pralnia/kotł.	4,67 m <sup>2</sup>
0.6	Toaleta	3,40 m <sup>2</sup>
0.7	Pom. gosp.	5,16 m <sup>2</sup>
<b>SUMA PARTER=</b>		<b>54,69 m<sup>2</sup></b>
1.1	Korytarz	4,94 m <sup>2</sup>
1.2	Łazienka	5,21 m <sup>2</sup>
1.3	Sypialnia	12,77 m <sup>2</sup>
1.4	Sypialnia	14,30 m <sup>2</sup>
1.5	Sypialnia	9,98 m <sup>2</sup>
1.6	Pom. gosp.	2,88 m <sup>2</sup>
<b>SUMA PIĘTRO=</b>		<b>50,08 m<sup>2</sup></b>
<b>SUMA P.UŻ. LOKALU=</b>		<b>104,77 m<sup>2</sup></b>



# OSIEDLE BAJKOWE ETAP III

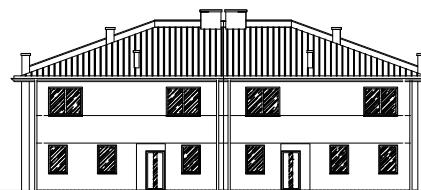
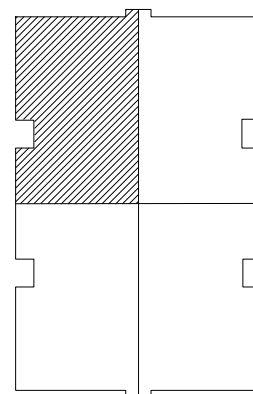
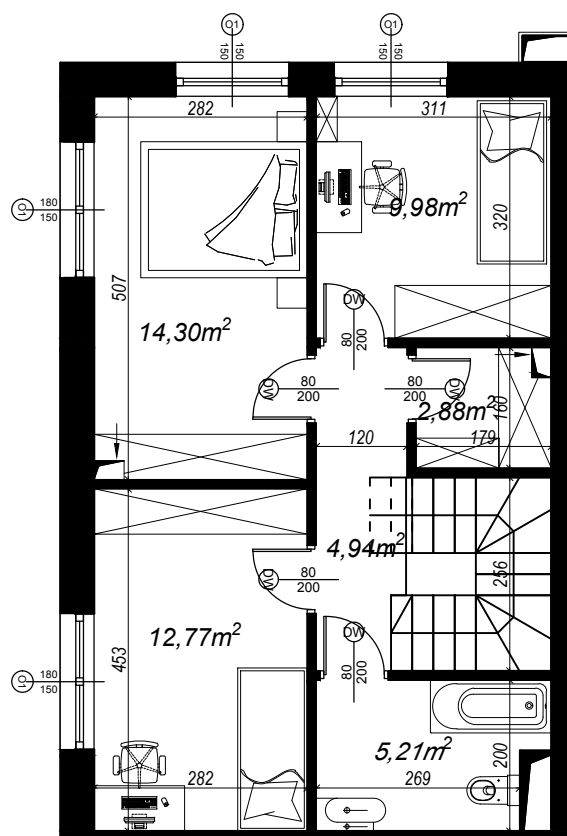

ELEWACJA FRONTOWA

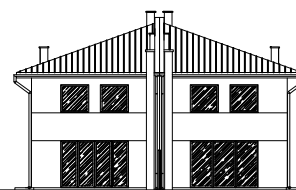

ELEWACJA BOCZNA

NR	NAZWA	POW
0.1	Wiatrołap	2,99 m <sup>2</sup>
0.2	Korytarz	4,31 m <sup>2</sup>
0.3	Salon z aneksem	29,08 m <sup>2</sup>
0.4	Schody	5,08 m <sup>2</sup>
0.5	Pralnia/kotł.	4,67 m <sup>2</sup>
0.6	Toaleta	3,40 m <sup>2</sup>
0.7	Pom. gosp.	5,16 m <sup>2</sup>
<b>SUMA PARTER=</b>		<b>54,69 m<sup>2</sup></b>
1.1	Korytarz	4,94 m <sup>2</sup>
1.2	Łazienka	5,21 m <sup>2</sup>
1.3	Sypialnia	12,77 m <sup>2</sup>
1.4	Sypialnia	14,30 m <sup>2</sup>
1.5	Sypialnia	9,98 m <sup>2</sup>
1.6	Pom. gosp.	2,88 m <sup>2</sup>
<b>SUMA PIĘTRO=</b>		<b>50,08 m<sup>2</sup></b>
<b>SUMA P.UŻ. LOKALU=</b>		<b>104,77 m<sup>2</sup></b>

